

DA 40A Roof Inlet

Technical Info

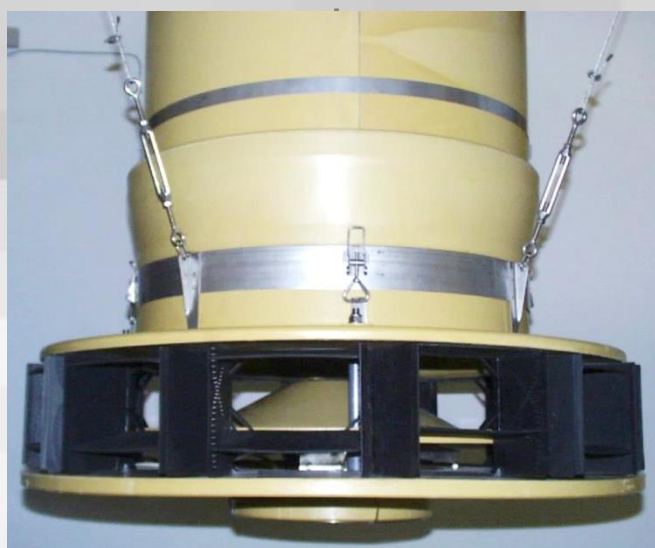

1 Product description

The roof unit DA 40A is used as air intake or air supply unit in both pig and poultry houses. The roof unit for inlet is made of polyester reinforced fibre glass for maximum weather resistance. Extension duct and air supply unit are made of polyurethane foam to reduce condensation. A small mixing fan for placement in the nozzle head is also supplied, where it ensures an optimum induction of the fresh air by which draft is avoided. If DA 40A is used as an air intake unit innegative pressure systems, the maximum performance is 4,500m³/h. If the air supply fan is installed, the performance is 5,000-8,400m³/h depending on type of fan and geometry of the house. Swivel shutter is always used for correct supply of air quantity and optimum setting of pressure. DA 40A is supplied with tilting fittings which ensure easy cleaning, inspection and servicing.

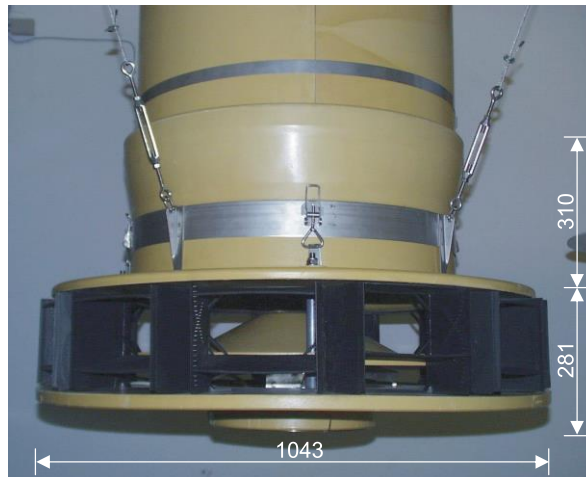

1.1 Mounting/installation

The roof sheet unit is delivered on the basis of information about roof pitch, roof profile, side/ridge installation, and in many cases it can directly replace the roof sheet, where it is installed. Extension ducts and air supply unit are installed with ss wires and turnbuckles directly up against the roof sheet unit which ensures an easy and stable construction. Alternatively, the attic can be used for air intake, in which case the roof sheet unit can be omitted.

1.2 Standard roof sheet profile

Other profiles can be supplied by forwarding a 1 × 1 m sample of the sheeting. Roof units for ridge installation are only available with flat sheeting.

2 Product survey

DA 40A roof inlet

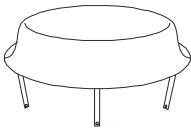

433410 DA 40A roof cap



434063 DA 600 roof cap ø1100, gray

The roof cap reduces water penetration problems; note, however, that the chimney output will also be reduced.

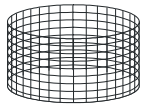

433424 DA 40A mesh for roof cap

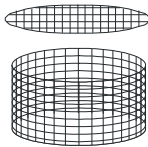

433427 DA 40A mesh for intake funnel

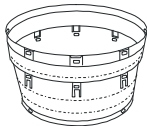

434431 DA 600 roof duct, gray

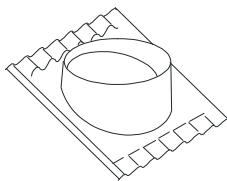

434040 DA 600 roof sheet, side, gray

The roof sheet is designed for mounting on the side and is available in different versions in terms of roofing sheet types and pitches.

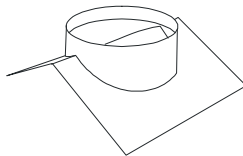

434045 DA 600 roof sheet, ridge, gray

The roofing sheet is designed for mounting on the ridge and is available in different versions in terms of roofing sheet types and pitches.

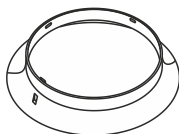

434471 DA 600 bell mouth, gray

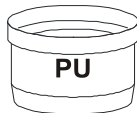

407746 DA 40A guiding pipe, insulated

Joiner between roof duct and PU duct.



434481 DA 600 duct 500 mm, gray



434212 DA 600 swivel shutter black



432055 DA 74 mount. set, flap in duct

Is used if several DA 74 are to regulate swivel shutter in duct. 1 stk. pr. DA 74 winch motor.

DA 40A roof inlet

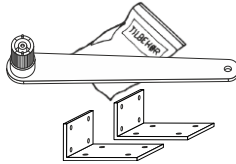

432056 Universal kit f. plastic swivel shutter

Is used if several DA 40A are to be linked mechanically. Use one for each DA 40A roof inlet.

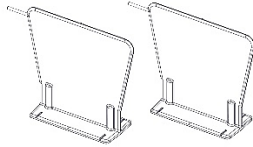

434008 DA 600/DA 820 air dir. baffles black

The baffle plates are used together with stepless fans and include two air baffle plates and mounting screws.

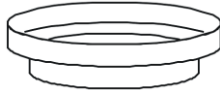

407748 DA 40A joiner, isolated/DA 600



407570 Tightening strap 650 ss

Use one for each 1/2 metre duct.

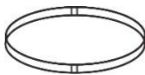

434031 DA 600 support ring

To be used if swivel shutter in DA 600 ducts.

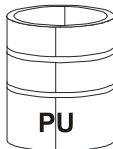

407566 Duct PU ø650x1000

Determine the meters of the extension duct by means of the preceding.



433420 Tension strap, plain 650 ss

Use two for each DA 40A roof inlet.



445016 DA 600 LPC 11-2 A fan 230V1 50/60Hz

See Technical info for the DA 600 LPC 11-2 A fan.

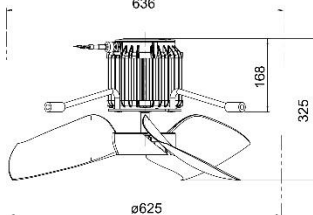

433404 DA 40A air supply unit

Inclusive of suspension parts and mixing fan.

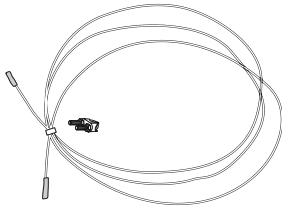
DA 40A roof inlet**413100 Solid wire, hardened ss, 2.5 mm**

Metre wire = distance between de pointes where the balancing is placed.

If the distance is *less than 30m*, coil springs are used at both ends.

If the distance is *more than 30m*, counter weights are used.

413250 Counterweight 160, 5 kg

3 Technical data

3.1 Output and fan data

Pressure in the house [Pa]	DA 40A without fan		DA 40A with DA 600 LPC-11-2 A
	With mesh and roof cap [m ³ /h]	With mesh and intake [m ³ /h]	With mesh and roof cap [m ³ /h]
0	0	0	8,700
-10	2,400	2,500	9,000
-20	3,500	3,600	9,300
-30	4,300	4,600	9,500
-40	5,000	5,400	9,800

Type of fan	Mixing fan under DA 40A	DA 600 LPC 11-2 A
Item number	Part of 433404	445016
Max. current consumption (rated current) [A]	1.1	2.8 A

3.2 Dimensions

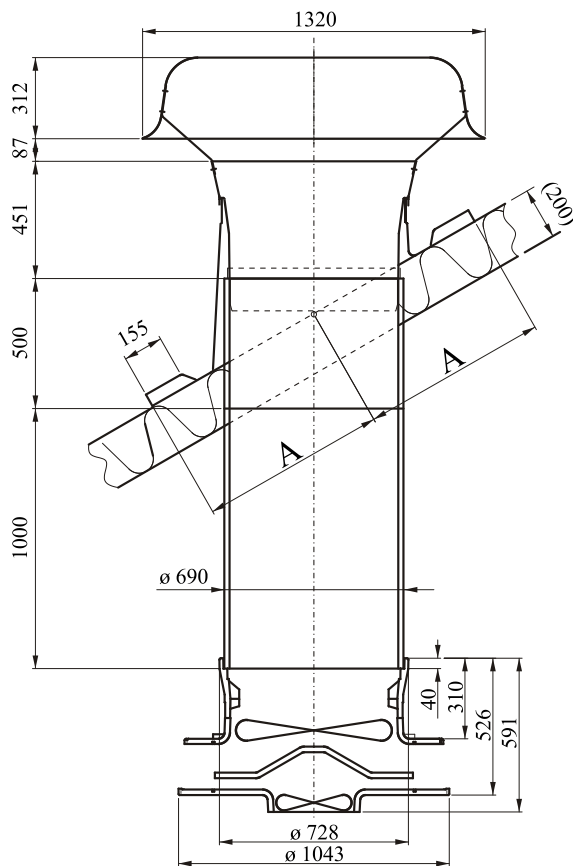

DA 40A side mounted	
Roof pitch [°]	A = mm
0	610
5	610
10	610
15	610
20	610
25	610
30	630
35	715
40	715
45	715
50	715

