

DOL 2400 • DOL 2300

Alarm System

Technical Info

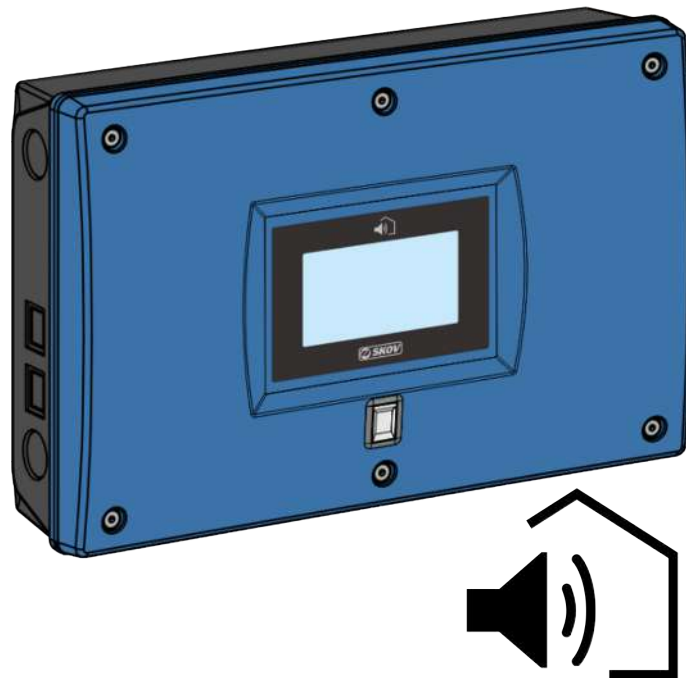

1 Product description

The DOL 2400/DOL 2300 alarm system is primarily used to monitor ventilation in livestock houses. The alarm system collects all incidents such as alarms and operation in a joint log, which can be used for analysis and statistics. The system can also be used for triggering alarms at equipment errors and other alarm situations.

Without extension the DOL 2400 can monitor the temperature in up to 20 house sections.

The alarm unit is not a fire alarm device, but when an additional sensor is connected to DOL 2400, it can signal a rapid temperature rise, which may indicate an ignition in the building. This feature is for informational purposes only and cannot replace a fire alarm. It is also possible to set up the DOL 2400 with surveillance to prevent unauthorized visitors from entering livestock houses.

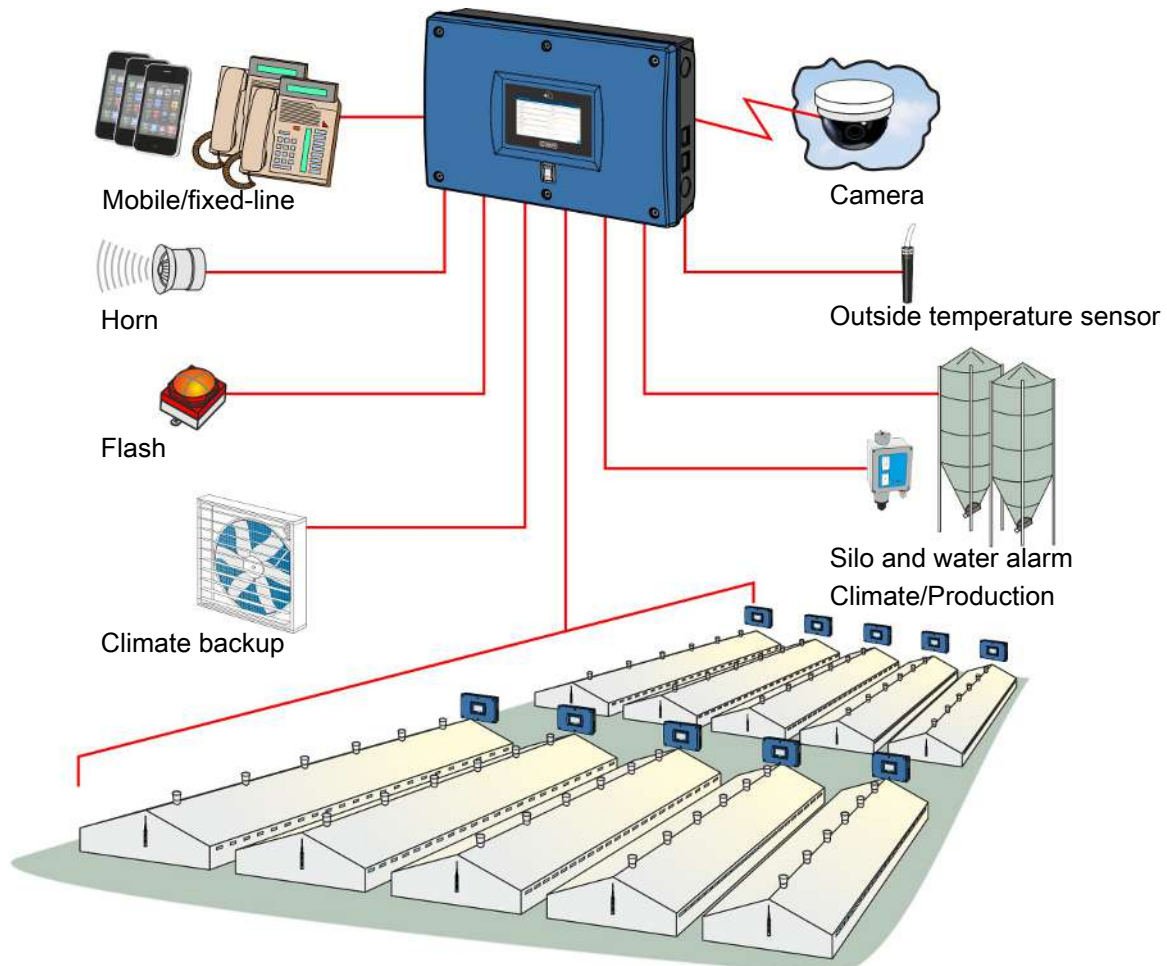

Figure 1: DOL 2400 alarm system

The alarm system consists of the DOL 2400/DOL 2300 alarm unit, input providers such as sensors and house controllers, and alarm indicators such as horns or text messages.

The DOL 2300 is a reduced edition of the DOL 2400. The DOL 2300 is different from the DOL 2400 in that it only has ON/OFF inputs and no climate backup and outputs. See the table 'DOL 2400 and DOL 2300 functionality'.

The alarm unit is available in several variants - with or without a fingerprint reader - and two sizes - with 10 or 20 inputs. Depending on the variant DOL 2400/2300 can notify alarms in a clear voice and send warnings via SMS, while the user can call or send an SMS to the unit to get alarm status or to acknowledge alarms. SMS is available when the alarm unit is fitted with a GSM modem. Furthermore, a fixed-line modem is available for areas with poor mobile coverage.

Accessories

As an accessory, an extension box comes with a further ten terminal inputs. Up to eight extension boxes can be connected to a large alarm unit and nine to a basic unit. Place the extension boxes immediately next to the alarm unit. Another extension option is to use a DOL 2400/DOL 2300 in a Master/Client system. It can be done in a LAN network, mainly where the alarm system covers a geographically large area. You can use up to nine client units in the same system.

Functions	DOL 2400	DOL 2300
Universal inputs:		
• Temperature	Yes	No
• Digital ON/OFF	Yes	Yes
• Analogue	Yes	No
• Other sensor types (see below)	Yes	No
Outside temperature sensor	Yes	No
Phase break relay	Yes	Yes
Climate backup	Yes	No
Video streaming (SMS with browser view URL)	Yes	No
Outputs	Yes	No
Master/client	Yes	Yes
Surveillance	Yes	No

Table 1: DOL 2400 and DOL 2300 functionality.

The alarm unit has the following characteristics:

Supervision

- Of temperature, humidity, empty silo, water, etc.
- Advanced temperature monitoring with outside temperature adjustment.
- Of building access via a login.
- Of its power supply and backup battery.
- Of its connection to external alarms.

Alarms

- Selecting alarm type: General alarms, silent alarms, and silent alarms at night.
- Alarm profiles.
- Local: Horn, flash, speakers.
- External: A phone call and SMS message.

User Management/Safety

- Fingerprint reader.
- 6-digit PIN.
- Safe user identification.
- Operation log.
- Central user management.

Overview and History

- One year log for all events.
- 30-day graphical log display of measurements.
- Viewing data with a ten minute time lag.
- Sound recording during an alarm.
- Access to camera streaming during an alarm.

Technical

- User-friendly touch screen with easily accessible overview menus.
- Voice controller reporting alarms.
- SMS message activation of the output for, for example, the fan for emergency ventilation.
- Up to nine extension boxes.
- Setup of the unit as master/client.
- Can activate backup ventilation or other equipment in case of an alarm.
- Battery, supervised by the alarm unit.

1.1 DOL 2400 input

The following sensor types can be connected to the DOL 2400. See Technical data for connection options.

- Temperature
- ON/OFF
- Extra temp*
- CO₂
- Pressure
- Humidity
- Air speed
- NH₃
- O₂
- Wind direction
- Light
- Analog
- Supervision

* An additional sensor can be used to inform about a rapid temperature rise, which may indicate an ignition in the building.

Alternatively, the inputs can be used to generate alarms for empty silos, jammed augers, faulty oil burners, and for access surveillance.

Extension box

If more inputs are needed in the same location than the 10 or 20, which the unit already has, then the alarm system can be extended with up to nine extension boxes to a standard alarm unit and up to eight to a large alarm unit.

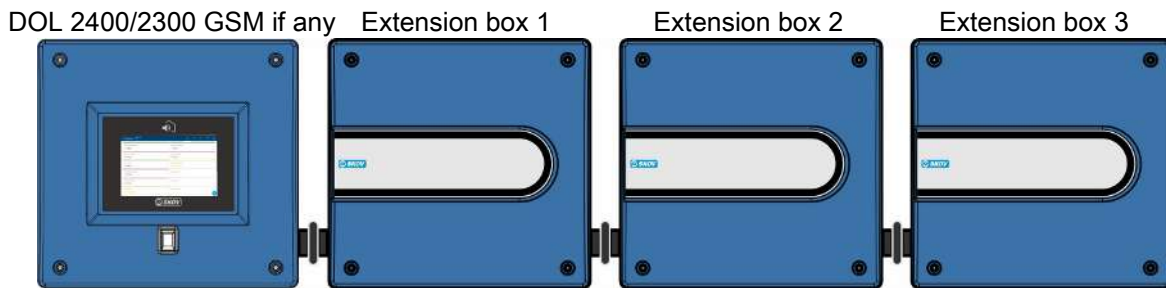

Figure 2: A schematic drawing for connection of extension boxes, which must be placed physically in the same location.

Master/client system

For alarm systems on geographically dispersed locations, the units can be set up in a master/client system of up to ten units in total.

All units function via the same telephone connection and with communal alarms and user management. In this system, only the SIM card for the GSM connection is required. Insert the SIM card in the unit that is set up as a master.

The master/client system requires that the units be part of a LAN network.

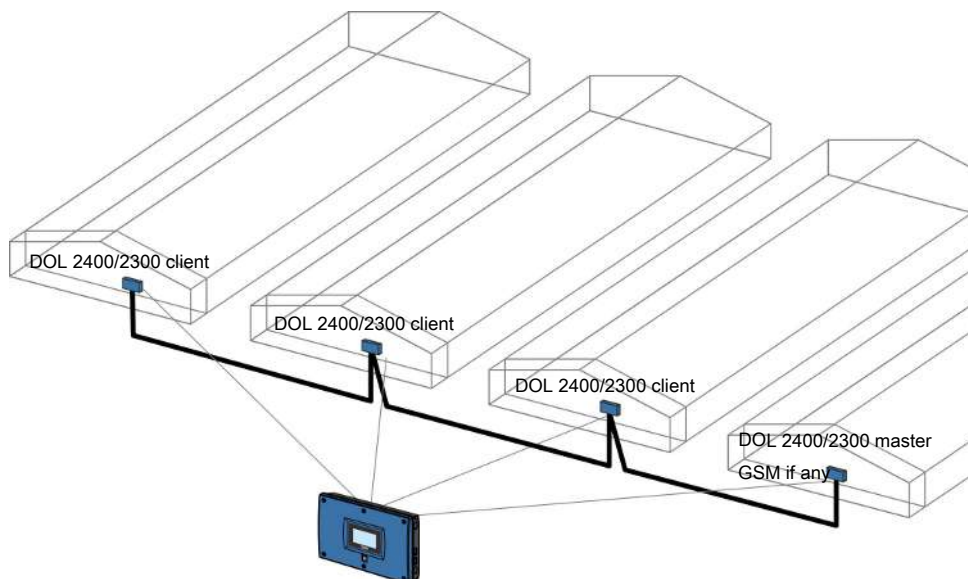

An example of master/client system connected to a LAN network. The alarm unit can be placed in different physical locations.

The alarm units can be connected in series as there are 2 Ethernet - ports in the units.

1.2 DOL 2400 outputs

DOL 2400 outputs can be used for the functions climate backup and relay output.

Climate backup

The DOL 2400 can activate set outputs such as emergency opening and cooling when a temperature input terminal records a temperature at a user-defined limit. If the limit is set slightly above the standard alarm limit, the function can be used as an extra backup for climate control.

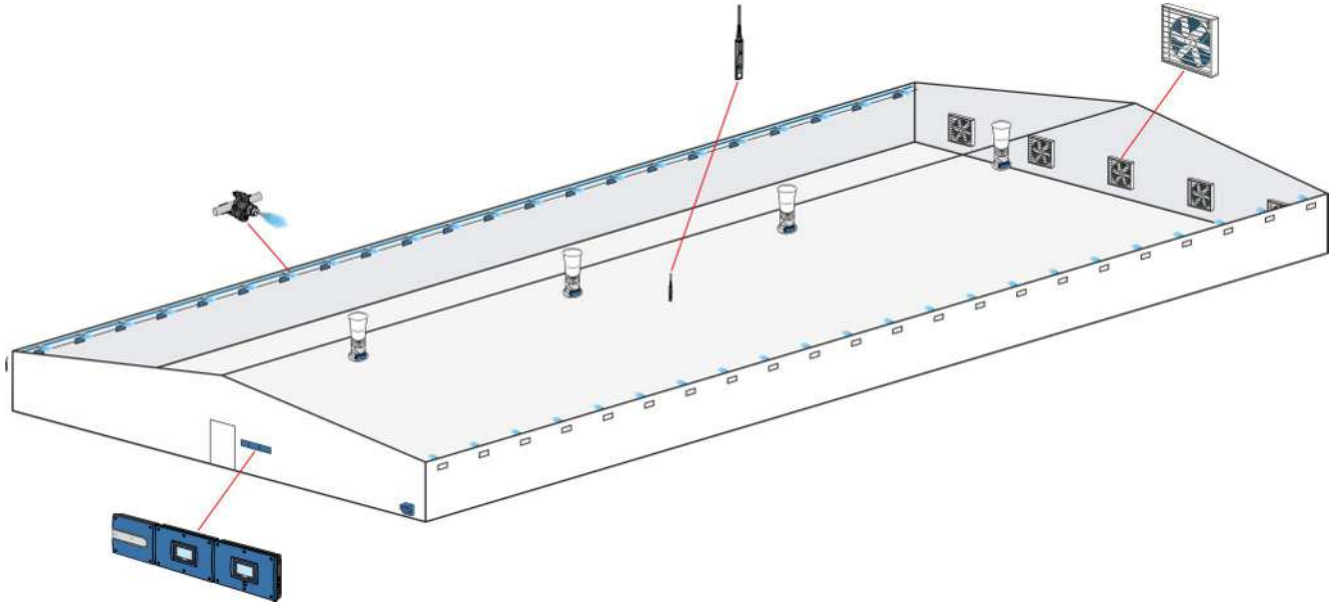

Figure 3: Example of climate backup

A temperature sensor registers temperatures that are too high, activates fans and/or opens an extra air inlet.

Relay

Each output can be connected to one of the inputs in the system.

If, for instance, an output is connected to one or several temperature sensors to record rapid increases in temperature, the output can activate sprinkling or high-pressure cooling when one or several sensors detect a rapid increase in temperature. See also below.

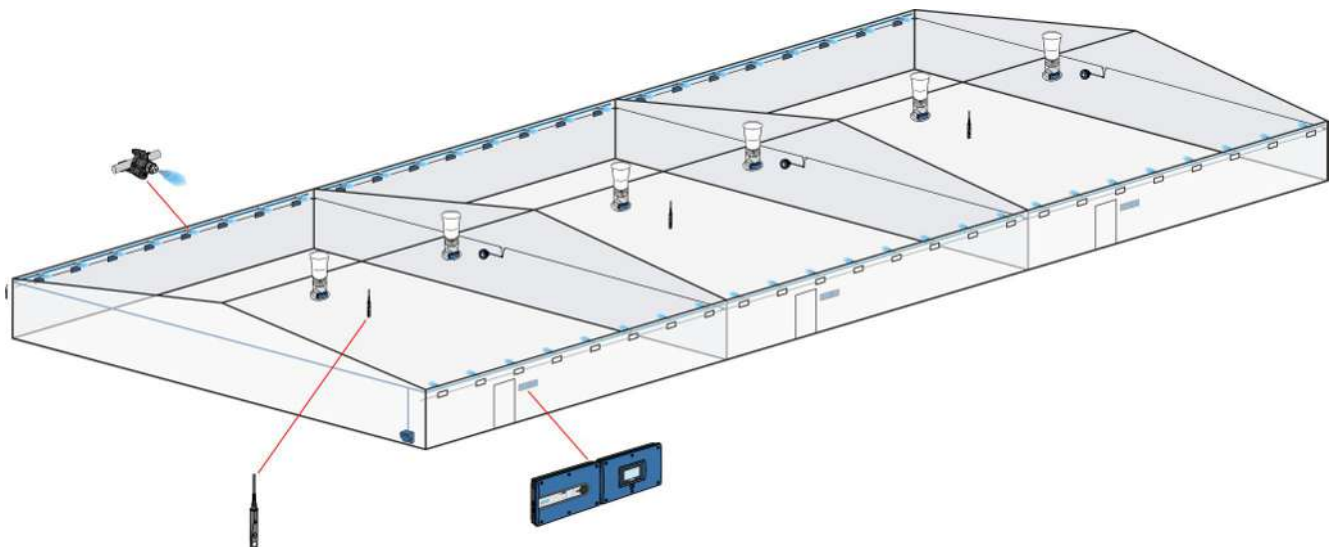

Figure 4: Example of relay

Multiple temperature sensors can activate high-pressure cooling / sprinklers in case of rapid temperature rise.

2 Product survey



134891 DOL 2400 alarm 7" Basic

134628 DOL 2400 alarm 7" w/fingerprint reader Basic

Inputs:

10 universal inputs: ON/OFF / 0-10V / DOL 12

One supervision from phase break relay

One outside temperature sensor

Outputs:

10 Output relays

1 Horn relay

1 Warning light relay

1 Alarm relay

The DOL 2400 comes with a battery, resistances for cable monitoring and an English manual package.

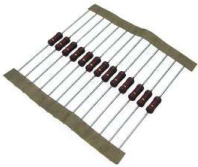
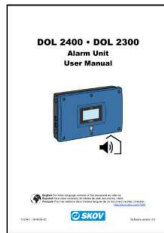

134899 DOL 2400 alarm unit Large 7" Basic

20 universal inputs: ON/OFF / 0-10V / DOL 12

One supervision from phase break relay

One outside temperature sensor

Outputs:

20 Output relays

1 Horn relay

1 Warning light relay

1 Alarm relay

The DOL 2400 comes with a battery, resistances for cable monitoring, and an English manual package.

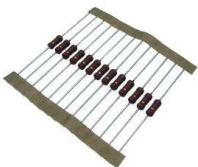



134864 DOL 2400 alarm 10" Basic

10 universal inputs: ON/OFF / 0-10V / DOL 12

One supervision from phase break relay

One outside temperature sensor

Outputs:

10 Output relays

1 Horn relay

1 Warning light relay

1 Alarm relay

The DOL 2400 comes with a battery, resistances for cable monitoring, and an English manual package.

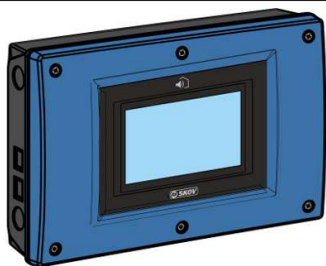
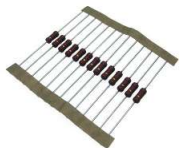

134865 DOL 2400 alarm 10" Large Basic

134866 DOL 2400 alarm 10" w/fingerprint reader Large Basic

20 universal inputs: ON/OFF / 0-10V / DOL 12

One supervision from phase break relay

One outside temperature sensor

Outputs:

20 Output relays

1 Horn relay

1 Warning light relay

1 Alarm relay

The DOL 2400 comes with a battery, resistances for cable monitoring, and an English manual package.

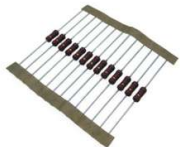



134873 DOL 2400 alarm unit WB 7" Basic

Inputs:

10 universal inputs: ON/OFF / 0-10V / DOL 12

One supervision from phase break relay

One outside temperature sensor

Outputs:

10 Output relays

1 Horn relay

1 Warning light relay

1 Alarm relay

The DOL 2400 comes with battery, resistances for cable monitoring and an English DOL 2400/2300 manual package, technical user guide for DOL 2400 in wiring box and DOL 2400 wiring box template.



134668 DOL 2400 alarm 7" unit w/fingerprint reader EMEA

Inputs:

10 ON/OFF inputs

One supervision from phase break relay

One outside temperature sensor

Outputs:

10 Output relays

1 Horn relay

1 Warning light relay

1 Alarm relay

The DOL 2400 comes with battery, GSM alarm modem, resistances for cable monitoring and an English manual package.

This variant is especially for the Middle East and North Africa.





134669 DOL 2400 alarm 7" w/fingerprint reader EMEA Large

Inputs:

- 20 ON/OFF inputs
- One supervision from phase break relay
- One outside temperature sensor

Outputs:

- 20 Output relays
- 1 Horn relay
- 1 Warning light relay
- 1 Alarm relay

The DOL 2400 comes with battery, GSM alarm modem, resistances for cable monitoring and an English manual package.

This variant is especially for the Middle East and North Africa.

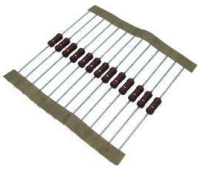
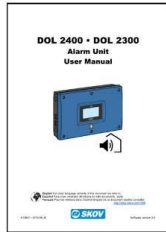

134890 DOL 2300 alarm 7" Basic

Inputs:

- 10 ON/OFF inputs
- One supervision from phase break relay

The DOL 2300 comes with a battery, resistances for cable monitoring, and an English manual package.

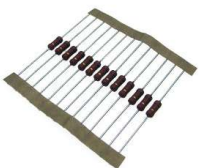



134639 DOL 2300 alarm 7" Large Basic

Inputs:

20 ON/OFF inputs

One supervision from phase break relay

Outputs:

1 Horn relay

1 Warning light relay

1 Alarm relay

The DOL 2300 comes with a battery, resistances for cable monitoring, and an English manual package.

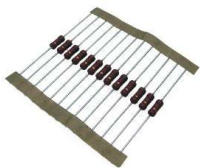
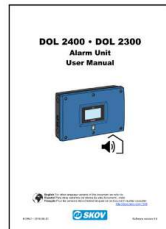

134898 DOL 2300 upgrade to DOL 2400

They are used where it is necessary to provide additional functionality or multiple analog inputs.

The upgrade is delivered as a USB stick and comes with an Installation Guide.

2.1 Languages

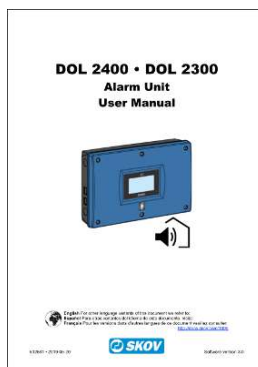

135140 DOL 2400-DOL 2300 manual package DA

135141 DOL 2400-DOL 2300 manual package EN

135142 DOL 2400-DOL 2300 manual package DE

134144 DOL 2400-DOL 2300 manual package FR

135147 DOL 2400-DOL 2300 manual package SV

135149 DOL 2400-DOL 2300 manual package CS

135151 DOL 2400-DOL 2300 manual package RU

135161 DOL 2400-DOL 2300 manual package ZH

The manual package contains user documentation in the selected language and an English technical manual.

Some manual packages also contains the technical manual in the selected language instead of English.

If several units are ordered it is not necessary to order a manual package for each.



Display Language

- DA – Danish
- EN – English
- DE – German
- NL – Dutch
- FR – French
- ES – Spanish
- SV – Swedish
- NO – Norwegian
- CS – Czech
- PL – Polish
- RU – Russian
- HU – Hungarian
- IT – Italian
- RO – Romanian
- SL – Slovenian
- HR – Croatian
- TR – Turkish
- TH – Thai
- JA – Japanese
- SR – Serbian
- PT – Portuguese
- ZH – Chinese
- KO – Korean
- SF – Finish
- BG – Bulgarian
- UK – Ukrainian
- LV – Latvian

2.2 Accessories

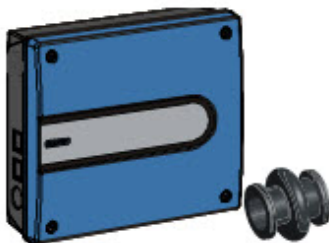

134889 DOL 2300/2400 extension 10RL

The extension box used where there is a need for extra inputs and outputs. Up to nine extension boxes can be added to a standard alarm and up to eight to a large alarm.

Inputs:

10 universal inputs: ON/OFF / 0-10V / DOL 12

Outputs:

10 output relay

Comes with a rubber sleeve and connection cable.

In each alarm system a maximum of 100 inputs and 20 outputs can be used.

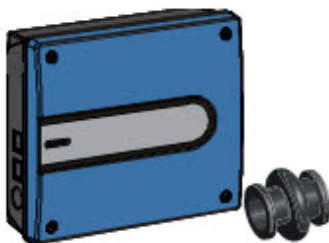

134625 DOL 2300/2400 extension 20RL

The extension box is used where there is a need for extra inputs and outputs. Up to 4 extension boxes can be added to an alarm unit.

Inputs:

20 universal inputs: ON/OFF / 0-10V / DOL 12

Outputs:

20 output relays

Comes with a rubber sleeve and connection cable.

In each alarm system a maximum of 100 inputs and 20 outputs can be used.



134883 Fixed-line alarm modem

The fixed-line alarm modem is for retrofitting in the alarm cabinets. With a fixed-line alarm modem the alarm units can call out and be operated via telephone.

Comes with a USB connection cable and telephone cable as well as lightning protection.

If using a DOL 2400 as a client unit, the telephone connection from the master unit can be used.



134680 DOL 2300/2400 external antenna - 10 m

An external GSM antenna is used where there is a need for better mobile reception than what is available with the built-in antenna. Comes with 10 meters cable.



134708 Cable ext. for cellular aerial - 10 m

10-meter cable extension for external antenna.
Used where the antenna is located far from the unit.



134863 DOL 2X00 aerial adapters GSM

Aerial adapter for 10 m aerial.
Used with existing 10 m aerial for example.



134867 4G modem EU (Europe, Middle east, Africa)

137840 4G modem AP (Asia Pacific region)

137841 4G modem LA (Latin America)

137842 4G modem NF (North America)

137843 4G modem CN (China, India)

The alarm modem GSM is for retrofitting in the alarm cabinets. With the alarm modem GSM and a mobile subscription the alarm unit can call and receive calls as well as send and receive SMS messages via the mobile network.

Order the correct version for your country. See also 4G Modem Country List.

If using a DOL 2400 as a client unit, the telephone connection from the master unit can be used.



140200 DOL 12 temperature sensor, 1.4 m cable

S140200A DOL 12 temperature sensor, 5 m cable

The Temperature Sensor can be used both outdoors and indoors.

If using a DOL 2400 as a client unit, the outside temperature registration from the master unit can be used.



140252 DOL 114 humidity and temperature sensor, 2 m cable

140253 DOL 114 humidity and temperature sensor, 5 m cable

The DOL 114 is a dual-purpose temperature and humidity sensor that can be used for monitoring the livestock house relative air humidity and temperature.

The DOL 114 is a high-quality sensor which is especially useful under particularly harsh conditions and in areas of high air humidity, e.g. where tunnel ventilation is used.

The DOL 114 comes with a protective cap.



140245 Radiation shield for climate sensors

The radiation shield protects an outside temperature and/or humidity sensor from rain and radiant heat.

SKOV A/S recommends that the Climate Sensor Radiation Shield is positioned 2 m above the roof. Alternatively 2 m above the ground and 2 m from other building elements (walls etc.)

The radiation shield comes with mounting fittings.

It may be necessary to order a climate sensor with a long cable when using the radiation shield.



140330 DOL 119 CO₂ sensor med adapter cable

Sensor for measuring the CO₂ content in the air. Supplied with a M12 plug and sealing plug as well as protection cap for DOL 119, also including adapter cable for fast replacement of DOL 19 with DOL 119 0-10V.



140331 DOL 119 CO₂ sensor 5000/10000 PPM

Sensor for measuring the CO₂ content in the air. Supplied with a M12 plug and sealing plug as well as protection cap for DOL 119.



140247 DOL 53 ammonia sensor

140236 DOL 53 dust filter (5 pcs)

DOL 53 measures levels of ammonia in the air in livestock house.

Can be used for registration of the ammonia levels in the air.

**140268 DOL 16 Light Sensor 0-100/1000LUX 0-10V**

Output 1: 0-100 lux. Output 2: 0-1000 lux.

140270 DOL 16 Light Sensor 0-50/1000LUX 0-10V

Output 1: 0-50 lux. Output 2: 0-1000 lux.

The sensor can be used to measure the light intensity for primary light and slave light, respectively.

Select the type of sensor that corresponds to the current brightness in the livestock house (measuring area).

Sensor with fixed cable.

**140333 DOL 18 v2 elec. sub-pressure sensor 100 Pa****140334 DOL 18 v2 elec. sub-pressure sensor 300 Pa**

Sensor for measuring the pressure level in the house.

DOL 18 hose set must be ordered separately.

**140235 DOL 18 hose set**

Hose set for DOL 18 electronic sub-pressure sensor.

**300085 Transparent plastic hose ø7x5**

3 meters.

To be used if additional plastic hose is needed.

**437672 Extension nipple & 5/7 PVC tube set**

Extension nipples must be ordered if another hose type than 300085/140235 is used.

**140008 Phase break relay PPB02cm48****140014 Base 11 pins ZPD 11**

3 -phase / 3-phase + zero

Monitoring relay for phase sequence, phase break and asymmetry with a built-in time delay function.

Remember to order the Socket (140014) for mounting the Phase Break Relay.



140007 Alarm light 12 V

There are no limits to how many alarm lights you can connect to the same alarm system.



140010 Horn 12-24V DC 30mA 80-111dB

The low power consumption allows several horns to be connected in parallel as it does not reduce the battery backup time significantly.



140011 Horn 12V 0.8A 118dB

The alarm system battery is able to sustain this horn for approximately 3 hours. If two horns are connected, the capacity is approx. 1½ hours.

If additional battery capacity is required, this can be bought separately, e.g. 140035 Battery ext. 12V 2x7Ah alarm w/cable



140035 Battery ext. 12V 2x7Ah DOL 2200 w/cable

To be used where there is a need for further battery capacity, for example for five or more extra I/O modules.

3 Technical data

Alarm unit		
Electrical		
Rated voltage	V AC	115 - 230 ± 20 %
Operating voltage	V AC	103 - 276
Frequency	Hz	50 / 60
Output	W	100
Max. current consumption	A	0.7
Battery	V AH	12 7
Main module input terminals		10 x all-purpose input terminals ON/OFF / 0-10V / DOL 12 Place 2 100 Ω cable monitoring resistors at the ON/OFF input terminals. One in series and one in parallel with switch (detects short-circuit or cable breakdown)1 x supervision from phase break relay1 x key switch1 x outside temperature sensor
Main module outputs (Only DOL 2400)	10 x output relay 1 x horn relay 1 x flash relay	12-230 V AC/ DC 4 A AC2
	1 x alarm relay	Max. 24 V 2 A. Min. 12 V 10 mA AC1
I/O module Inputs (Only DOL 2400)		10 x all-purpose input terminals ON/OFF / 0-10V / DOL 12 Place 2 100 Ω cable monitoring resistors at the ON/OFF input terminals. One in series and one in parallel with switch (detects short-circuit or cable breakdown)
I/O module outputs (Only DOL 2400)		10 x output relays 12-230 V AC/ DC 4 A AC2
Miscellaneous		
Fingerprint scanner		Variant
Microphone		Built-in
Loudspeaker		Built-in, 3 W
Cable dimensions		DOL 114 1.50 mm ² = 200 m DOL 12 1.50 mm ² = 200 m ON/OFF input 1.50 mm ² = 200 m
Network		
Network interface		2 x 10/100 BASE+TX RJ 45 3 USB 2.0 A type - 2GB (formatting requirement: FAT16) - 2-32GB (formatting requirement: FAT32)
Accessories		
Fixed-line (PSTN) module		Analog module, DTMF signaling
Mobile (GSM) module	MHz	699-960, 1710-2620
Mobile (GSM) signal level	dBm	Minimum (minus) -90
Outdoor mobile antenna		Incl. 10 meter cable

Alarm unit		
Extension box		With one type 16 I/O module
Environment		
Temperature, operation	°C (°F)	-10 to +40 (+14 to 140)
Temperature, storage	°C (°F)	-25 to +60 (-13 to +140)
Ambient humidity, operation	% RH	0-80
Protection class	IP	54 (splashproof) It is assumed that the base surface is level, i.e. ≤ 1.5 mm height difference, and the front panel screws are tightened to a minimum of 1.5 Nm.

Mechanical			
Cable knock-out punches		Large	Small
		30 x M25 For metrical cable glands	20 x M25 For metrical cable glands
Shipment			
		Large	Small
Dimensions (H x W x D)	mm	381 x 568 x 170	381 x 400 x 170
Dimensions crated H x W x D	mm	421 x 608 x 230	425 x 555 x 195
Weight	g	7800	5800
Shipping weight	g	9200	6900

3.1 Dimensioned sketch

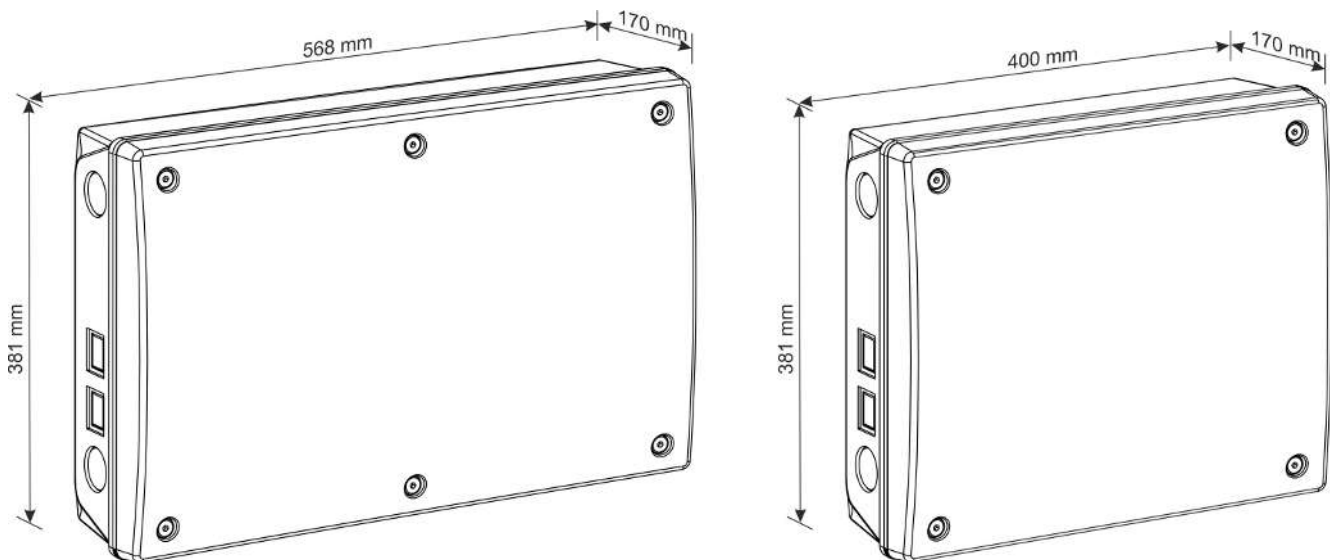

SKOV A/S • Hedelund 4 • Glyngøre • DK-7870 Roslev
Tel. +45 72 17 55 55 • www.skov.com • E-mail: skov@skov.dk

